

Equipment Catalogue

Grinding, Polishing & Surface preparation

- Planetary grinding machine
- Square rotary grinding machine
- Shot blasting machine
- Scarifier / Shaver
- Dust collector
- Power trowel polishing system



INGYI

NO.34 JUXIAN Road, Anping Development Area,
Quanzhou City, Fujian Province, China.

USA/Thailand/Germany/UAE/India/Malaysia

Email: info@xingyimachine.com
Whatsapp: +86-15960788816/+86-15960731060

www.xingyimachine.com
www.high-tech-grinding.com
www.conglory.com



2023 EDITION 2023

INGYI

CONTENT

Services	01 — 02
Technology	03 — 06
XINGYI MACHINE	
GX Series	07 — 10
LE Series	11 — 14
HIGH-TECH-GRINDING MACHINE	
HTG Series	15 — 18
TANK1500	19 — 22
Edge Grinder and Burnisher	23 — 24
Dust Collector	25 — 26
Diamond Tools	27 — 30
Propane machine	31 — 32
CONGLORY MACHINE	
Conglory Introduction	33 — 34
Heavy Grinders	35 — 36
Scarifier and Shaver	37 — 38
Shot Blasting and Dust Collector	39 — 42
Concrete Surface Profile	43 — 44
Sheencreting System	45 — 46

Company Profile

XINGYI started as a stone restoration company in 1999, and became known in the industry as one of the top caliber in providing services and for manufacturing high quality floor grinders, industrial vacuum cleaners, surface preparation and accessory machines worldwide.

XINGYI focuses on research and development of high-technology innovations and introduced semi-automatic and full-automatic technologies. In 2014, the first self-propelled planetary grinding machine in China was born in XINGYI. And in 2015, XINGYI developed its first remote control grinder which greatly enhance the productivity with smart control features. In the past 10 years, XINGYI and High-Tech-Grinding distributed more than 50,000 units of grinders and vacuums to over 130 countries and areas.

Our professionals continuously explore their applications from polishing to surface preparation. In 2021, XINGYI developed the first set of portable shot blasting machine with DIGISTEER system in the world. Its Scarifying, Shaving, Heavy Duty Grinding technologies in the equipment for high quality surface preparation are warmly welcomed in the market.

With the commitment to provide better experience and service to clients, Xingyi set up its sales & service centers around the world with a network of distributors and dealers. Contact us today for more information on subjects such as: Our technologies, spare parts, price, cost, technique, training or dealership. We are ready to assist you with all your floor construction needs at anytime and anywhere.

XINGYI

RESEARCH & DEVELOPMENT

XINGYI's strong R&D department ensures the continuous progress of XINGYI's technical level and manufacturing level. Our technologies for grinding and maintaining floors, preparation ready for your coating or layer and other surfaces are developed in-house. Operator's feeling and easy maintenance, robust and cost efficient, environment friendly are our basic rules of our research.

PRODUCTION

XINGYI Factory is located in Jinjiang City, Fujian Province, China, that has passed ISO9001 and SGS certification, and its equipment meets CE requirements, with a production and manufacturing workshop of 10,000 square meters. The main components of all equipment are completed in this factory with high standards of quality requirements. Including precision machining and assembly of gear boxes, cutting and welding of various types of machine sheet metal, painting, and assembly. The most part we produce them ourselves. Equipment is completed in one factory, ensuring self-control of the quality of the entire process.

SERVICES & SALES

Our team of international experts from all over the world will be happy to answer your questions and provide you with all the information you need. They will look for the best solution for your jobsite in terms of cost, time & productivity.

LOGISTICS AND AFTER-SALES

With operation & service centers in USA, Canada, Mexico, Thailand, Malaysia, Indonesia, UAE, Germany, Hungary, India, Malaysia and a large network of distributors and dealers covered North of American, Europe, Middle East, South-eastern of Asia in the industry, we are ready to assist you with all your flooring industry needs, anywhere and anytime. Thanks to our strong logistics department, XINGYI is able to deliver any machine or spare parts anywhere in the world. Depending on the size or format of the goods, we will find the most cost-effective solution in order that you receive your order on schedule.

Product Applications

Fujian XINGYI Polishing Machine Co., Ltd is a transnational company that covers the entire process from design, manufacture to sales and service. The product includes equipment for concrete paving, various coating, grinding, blasting, scarifying and cutting of waterproof surface treatment, polishing, finishing and maintenance of various surface layers, and its matching vacuum cleaner and tools.

XINGYI and its sub-brand HTG and Conglory offer products and services in the following areas:

- Surface preparation for various coated floor
- Grinding and polishing of polished concrete and floor surface
- Floor resurfacing, cleaning and maintenance
- Waterproofing material pavement
- Build and maintenance of road
- Surface preparation of steel plate
- Landscape pavement
- Concrete pavement



THE REVOLUTION MADE-IN CHINA

The grinding machine from XINGYI



XINGYI grinding machines are all driven by gear. The gear-driven system has some prominent advantages: Accurate transmission ratio, convenient maintenance at low cost, high transmission efficiency, stable and reliable output.

- Patented technology of aluminium alloy and steel insert casting builds a reliable gearbox.
- Patented technology of oil circulation system to ensure cooling of upper and lower floor of the gearbox.

All Xingyi machines are welded with thickened steel plates, strong and reliable.

Tool plates fit multi-brand abrasives to meet different application requirements.

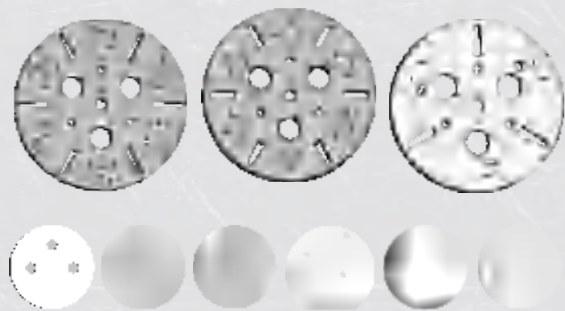

The ergonomical designs are packaged as following: LED light, adjustable handle for comfortable operation, a spray system (on some models) and an easy-tilt structural.



The machine is equipped with a water tank and a vacuum cleaner quick connector. This allows two working modes: dry and wet grinding.

Integrated, adjustable position of the additional weights make the machine has different grinding pressure, suitable for different kinds of flooring and tools.



TECHNOLOGY

The XINGYI and HTG ranges are designed to work in three modes: walk behind, self-propelled and remote control.

SELF-PROPELLED is ideal for medium to large size as it improves the efficiency effectively and reduce the labor fatigue greatly.

XINGYI: The first self-propelled advocator in China.

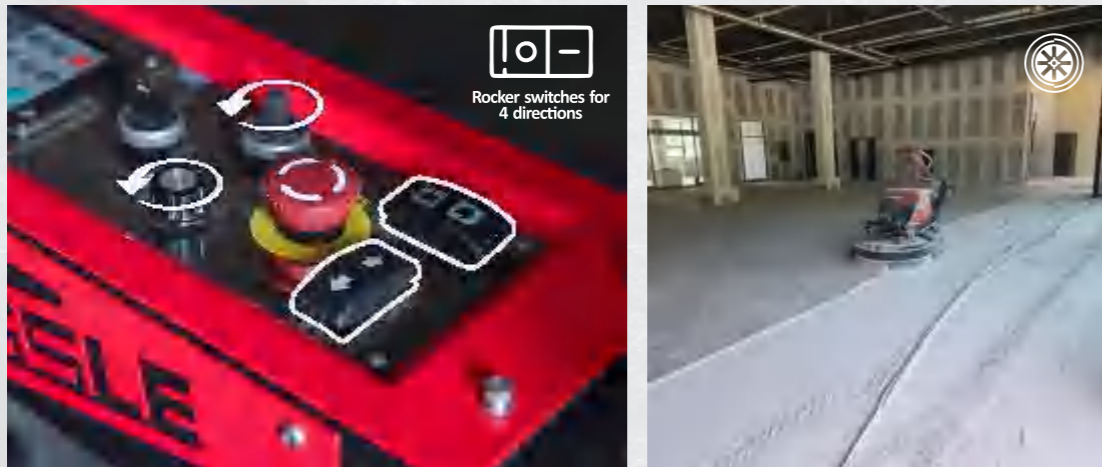

The keys on the control panel set the driving speed, forward and backward of the machine running. Motor, wheels, lights are operated on a centralized panel gives the operator a great feeling of control while require less body strength. Speed cruise generates a more even and consistent floor.



The remote control device adopted patented servo control system, double motor drive.

The remote control technology of XINGYI is responsive in time and action without delay. The 360° adjustable joystick reflect the control power and speed of the operator accurately and synchronously. The colorful screen display the operating data of the machine clearly. More features include lighting, mist spray and oscillation. Some of the remote control machines have a button U-turn and memorize grinding function, HMI control.



The REMOTE CONTROL system is developed by XINGYI, with independent intellectual property rights.

It has a variety of ergonomical and practical control technologies, which are stable, reliable, fast in response, and easy to operate.



The Xingyi and HTG equipment that adopt SELF-PROPELLED or REMOTE CONTROL system, which can realise manual and automatic switching, suitable for your different operating requirements.

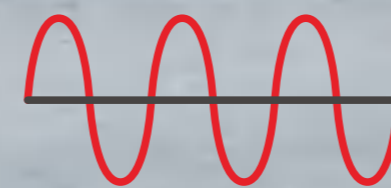
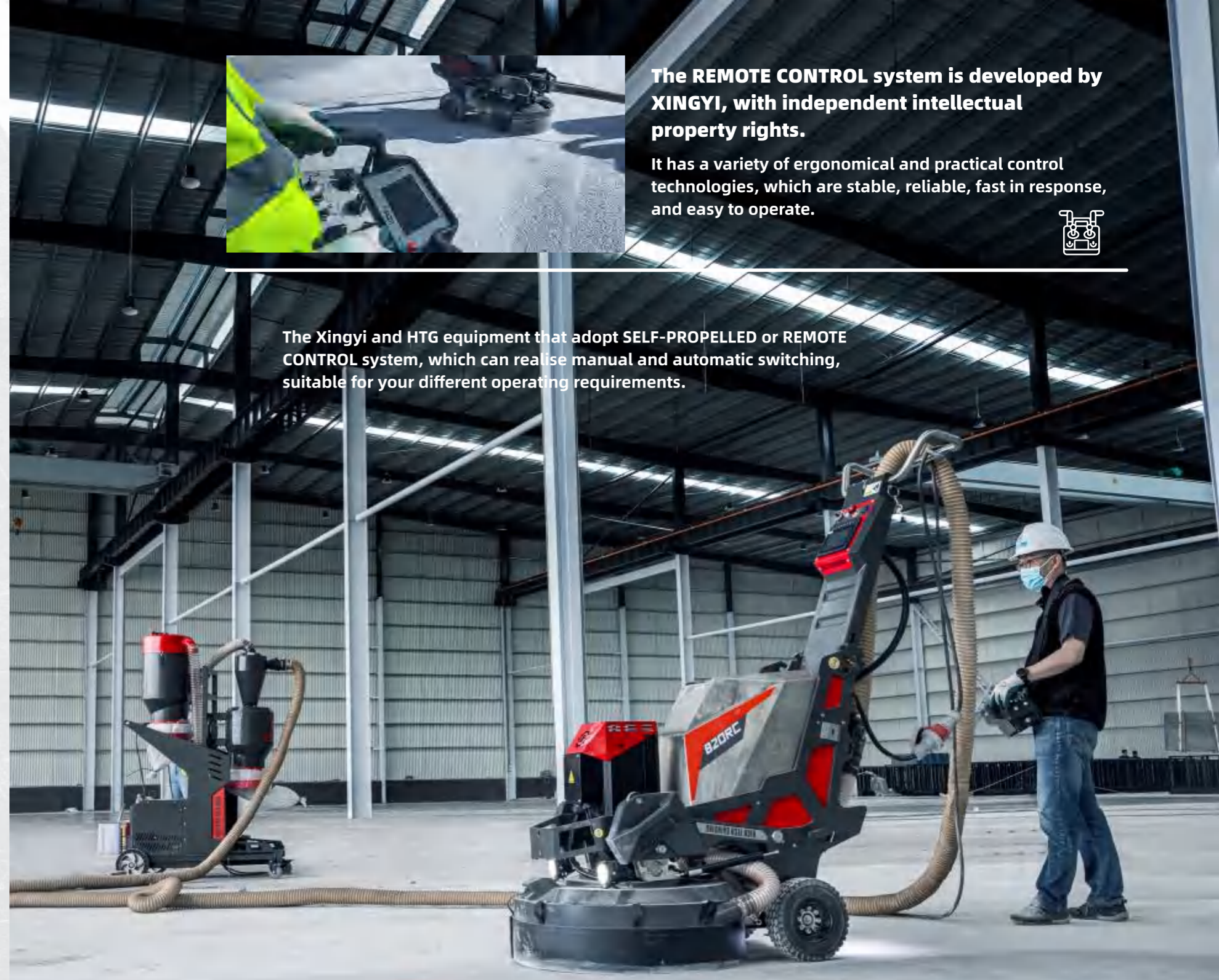

Oscillation function for smoother floors without ridges.

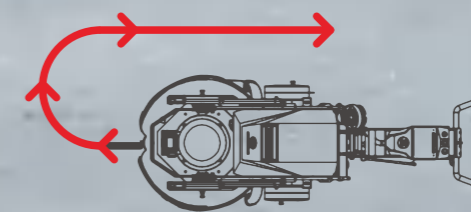

one button U-turn

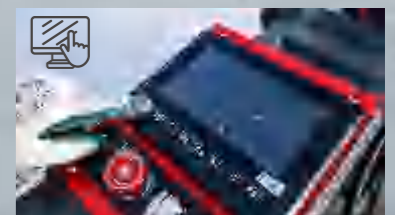

HMI control

GX

SIMPLE, ROBUST & PRACTICAL



GX



Ultra experience of our new GX grinder family.



The GX series grinding equipment is an upgrade of the classic QX machines with more than 10,000 clients in last decade. There are three shapes of the gearbox: square double-head and 4-head counter-rotating machines, 3-disc planetary machines. They are all built with solid steel. The machines are simple, strong, reliable and easy to operate.



GX-500

GX-580

GX-688

GX-650

GX-720

GX-550

GX-750

	GX-500			GX-580			GX-688			GX-650			GX-720		GX-550			GX-750					
Working Width	500mm			570mm			638mm			638mm			690mm		550mm			760mm					
Motor Power	5.5kW			5.5kW		7.5kW		11kW		15kW		9.5kW			15kW		4kW		5.5kW		11kW		
Voltage	380-480V 3P	200-240V 3P	200-240V 1P	380-480V 3P	200-240V 3P	200-240V 1P	380-480V 3P	200-240V 3P	200-240V 1P	380-480V 3P	200-240V 3P	200-240V 1P	380-480V 3P	200-240V 3P	380-480V 3P	200-240V 3P	200-240V 1P	380-480V 3P	200-240V 3P	200-240V 1P	380-480V 3P	200-240V 3P	200-240V 1P
Frequency	50/60hz			50/60hz			50/60hz			50/60hz			50/60hz		50/60hz			50/60hz					
Rotating Speed	350-1680rpm	350-1500rpm		350-1680rpm	350-1500rpm		350-1500rpm	350-1680rpm		350-1680rpm	350-1500rpm		350-1680rpm		350-1680rpm	350-1500rpm		350-1950rpm	350-1500rpm				
Grinding disc	270mm*4			310mm*2			348mm*4			348mm*4			380mm*4		230mm*3			256mm*3					
Mode of operation	Walk-behind			Walk-behind			GX688 Walk-behind / GX688-A Self-propelled			Walk-behind			GX-718 Walk-behind / GX-720 Self-propelled		Walk-behind			Walk-behind					
Water Tank	25L			25L			30L			30L			30L		25L			30L					
Weight	237kg			218kg	228kg		399kg	410kg		317kg			456kg		221kg	230kg	230kg	348kg					
Appearance size	1667*500*1066mm			1544*580*1082mm			2031*650*1187mm			1980*650*1135mm			2177*690*1185mm		1651*520*1087mm			2126*760*1160mm					

www.xingyimachine.com



LE



Product Applications

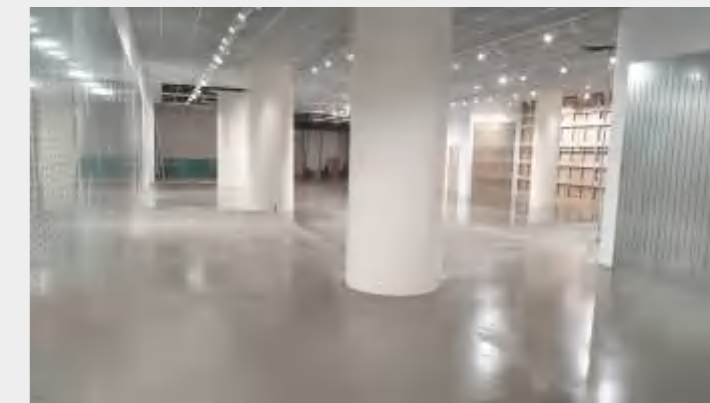
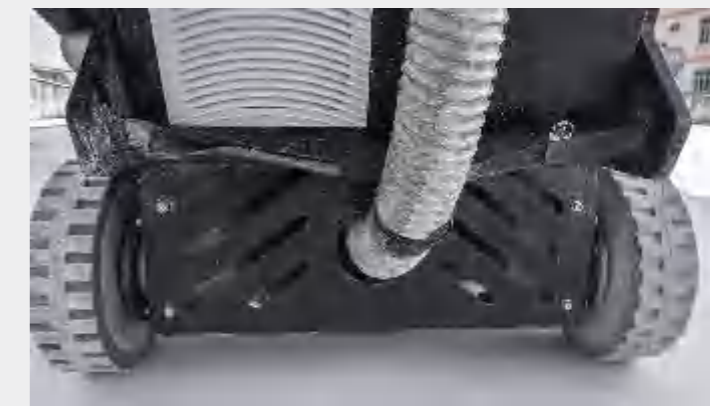

955LE

850LE

800LE/800LE plus

Working Width	955mm	815mm	793mm
Motor Power	22kW	15kW	15kW
Voltage	380-480V 3P 200-240V 3P	380-480V 3P 200-240V 3P	380-480V 3P 200-240V 3P
Frequency	50/60hz	50/60hz	50/60hz
Rotating Speed	350-1500rpm	350-1950rpm	350-1950rpm
Grinding disc	370mm*4	278mm*4	256mm*4
Mode of operation	Remote/Self-propelled/Walk-behind	Remote	Self-propelled / 800LE plus with integrated battery
Water Tank	20L	39L	39L
Weight	750kg	613kg	538kg
Appearance size	2402*979*1165mm	2266*825*1107mm	2450*850*1150mm

TOPOTENT 955LE

▶ The LE Series machines are XINGYI's classic medium to large 4-disc planetary machines with a sheet metal body in self-propelled or remote control mode.

www.xingyimachine.com



HTG

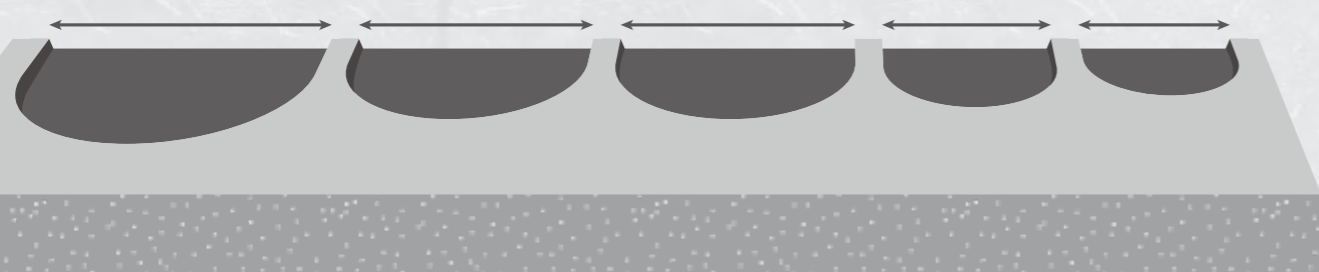

HTG -820RC

HTG-680RC

HTG-680-4A

HTG-550

HTG-460

Working Width	820mm	680mm	680mm	490mm	460mm
Motor Power	18.5kW	11kW	11kW	4kW 5.5kW	2.3kW
Voltage	380-480V 3P 200-240V 3P	380-480V 3P 200-240V 3P 200-240V 1P	380-480V 3P 200-240V 3P 200-240V 1P	380-480V 3P 200-240V 3P 200-240V 1P	200-240V 1P
Frequency	50/60hz	50/60hz	50/60hz	50/60hz	50/60hz
Rotating Speed	350-1950rpm	350-1950rpm	350-1950rpm	350-1680rpm 350-1500rpm	350-1500rpm
Grinding disc	278mm*4	230mm*4	230mm*4	220mm*3	200mm*3
Mode of operation	Remote/ Walk-behind	Remote/ Walk-behind	Self-propelled/ Walk-behind	Walk-behind	Walk-behind
Water Tank	25L	20L	20L	20L	15L
Weight	620kg	548kg	515kg	244kg 254kg	194kg
Appearance size	2305*833*1165mm	2305*833*1165mm	2120*705*1212mm	1176*524*1497mm	1539*462*927mm
	3 planetary discs available Working Width 780mm(278*3)	3 planetary discs available Working Width 660mm(230*3)			

The HTG series is a successful and proud innovation of XINGYI in 2014. Its unique design includes a high quality thick sheet metal body and a recognizable stainless steel water tank. It is designed in a family look with different sizes from small, medium to large. As the top quality of XINGYI products, all the gearboxes are manufactured with the most advanced technology. There are nice performance vacuums and abrasives to match with the grinders.



www.xingyimachine.com

TANK



Strong machine built for the most demanding projects.



TANK

RIDE-ON PLANETARY GRINDER

Tank-1500 is an effective concrete grinder to grind the large area in a short time. The collaboration of power, weight, control and operation of this machine make it outstanding in the industry.

The machine features an intuitive digital control panel which gives you continuous feedback. The hydraulic lift provides an easy way to change diamond tools. And 3D robot arms adjust automatically to keep consistent grinding pressure. Front and rear cameras help you to observe during the grinding process. A robust dust collector mounted accomplishes a dust-free operation. And it is easy to remove the grinding head and dust collector for transportation.



TANK-1500
1550mm



TANK-1500

Working Width	1500mm
Motor Power	18.5kW*2
Voltage	380-480V 3P
Frequency	50/60hz
Rotating Speed	450-1950rpm
Grinding disc	278mm*8
Mode of operation	Remote/Semi-auto pilot
Water Tank	25L
Weight	2100kg
Appearance size	3453*1590*2239mm(Dust collector included)

Dust collector

Motor	7.5 kW / 10 hp
CFM	441
Vacuum	35 kPa
HEPA H13 filter	3.86 m ³ > 99.99%@0.3um
Filter cleaning	Automatic jet-pulse
Dust collection	Continuous drop-down bag



The supplementary products include edge grinder and the high speed polishing machine needed for the whole grinding and polishing process.



HTG-250VS
250mm

HTG-250D
250mm



HTG-250VS

HTG-250D

Working Width	250mm	250mm
Motor Power	3kw	2.2kw
Voltage	380-480V 3P 200-240V 1P/3P	200-240V 1P/3P
Frequency	50/60hz	50/60hz
Rotating Speed	350-1500rpm	1500rpm
Grinding disc	250mm*1	250mm*1
Water Tank	/	10L
Weight	60kg	60kg
Appearance size	1200*465*933mm	1200*465*933mm



HTG-27S
690mm

HTG-27S

HTG-27S Burnishing Pads

Working Width	690mm
Motor Power	7.5kw
Voltage	380-480V 3P 200-240V 3P
Frequency	50/60hz
Rotating Speed	350-1500rpm
Grinding disc	690mm*1
Weight	179kg

Grit	400# 800# 1500# 3000#
Specification	27"
	



HTG

Dust collector



HIGH-TECH-GRINDING DUST COLLECTOR CLEANING AND DUSTLESS OPERATION

All HTG vacuum/dust collector are equipped with HEPA filters with different power supply.

From single phase to 3 phase suitable for all equipment made by XINGYI or others. Working together with HTG dust collector makes the process almost dust free when in operation.

**IVC-F65****IVC-33L****IVC-45L****IVC-V3**

Motor Power	2.2 kW		3.3 kW		5.5 kW		3.3 kW	
Voltage	380V 3P	220V 3P	220V 1P	110V 1P	380V 3P	220V 3P	220V 1P	110V 1P
Weight	68kg		105kg		223.5kg		92kg	
Vacuum	25 kPa		25 kPa		35 kPa		20 kPa	
Maximum flow	385m ³ /h		537m ³ /h		600m ³ /h		573m ³ /h	
Filtration level	1.5m ² HEPA H13		1.5m ² HEPA H13		cyclone+2.8m ² HEPA H13		2.8m ² +2m ² HEPA 13	
Filter cleaning	Shaking back and forth		Shaking back and forth		Jet pulse by manual		Jet pulse by manual	
Hose	50mm		50mm		50/63/80mm		50mm	
Collection	Barrel		continuous drop-down bag		continuous drop-down bag		continuous drop-down bag	





More than 95,000 units of machine in use on construction sites around the world by the end of 2022.

Correct diamond tools work with the high technology equipment generates better finish.

Metal segments are designed for wet or dry floor applications with different bonds for different floor qualities. It is designed for aggressive scratching and exceptional durability with strong grinding capabilities.

Resin pads are designed to get good working efficiency on original concrete and terrazzo floors.

Type	Specification	Grit	Bond
HTG-2T	2*40*10*10mm	16#30#60#120#	VHB HB MB SB VSB XSB
HTG-2Y	2*24*13mm	30#60#120#	VHB HB MB SB VSB
HTG-3Y	3*24*13mm	30#60#120#	VHB HB MB SB VSB
HTG-2C	2*12*12*38mm	16#30#60#120#	HB MB SB VSB
HTG-2L	2*13*16*35mm	16#30#	VHB HB MB SB VSB
HTG-4T	100mm*4*40*10*10mm	16#30#60#120#	VHB HB MB SB VSB
HTG-2PCD-1C	2*1/3PCD *8mm*1C-Left/Right		
HTG-2CPCD	2*12*12*40 with split PCD		
Bush hammers	Teeth No.45		
HTG-DGW-CW	250mm*20T*40*10*10mm	16#30#	HB SB

Type	Specification	Grit	Application
HTG-4GW2	4"*6mm	50# 100# 200# 400#	Wet polishing
HTG-C3510	3.5"*10mm	50# 100# 200# 400# 800# 1500# 3000#	Dry polishing
HTG-XR	3"*10mm	50# 100# 200# 400# 800# 1500#	Dry polishing
Star-Resin Polishing Pads HTG-C310	3"*10mm	50# 100# 200# 400#	Dry polishing
HTG-XZ	3"*10mm	400#800#1500#3000#	Dry polishing
Ceramic Transitional Diamond Grinding pad	3"*10mm	50# 100# 200#	Dry/Wet
Velcro plate adapter	Fits all standard XINGYI and HTG series chassis.		For all planetary disc equipment



Type	Specification	Grit
Premium polishing pads	Diameter: 9"/230 10"/250	50# 100# 200# 400# 800# 1500# 3000#
10 Inch circular polishing pad	Diameter: 10"/250	50# 100# 200# 400# 800# 1500# 3000#
Sunshine polishing pad	Diameter: 5"/125 10"/250	50# 100# 200# 400# 800# 1500# 3000#

The choice of diamond tools depends on the equipment you use, the expected cutting level, the hardness of the bond and the starting grit you need.

Type	HTG-2T	HTG-2Y	HTG-3Y	HTG-2C	HTG-2L	HTG-4T
#16						
#30						
#60						
#120						

Diamond Grinding Steps / grit

- Change tools to ceramic or resin pads
- Remove scratches made by metal discs
- Fill and repair pin holes
- Spray densifier according to material specs
- Check roughness with RA meter after each step
- Polish to final gloss and DOI

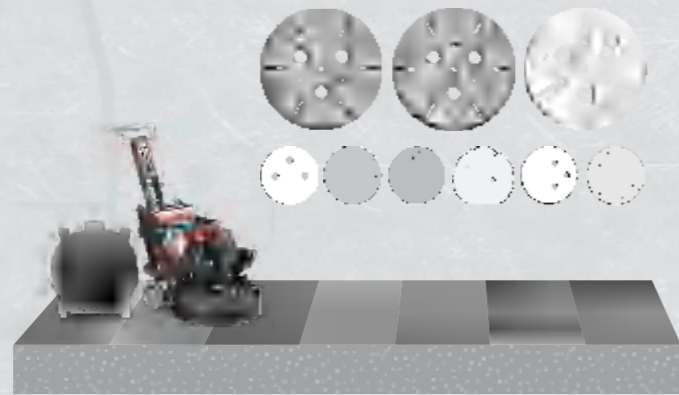

recommended rotation speed (RPM) of planetary discs



Type	ceramic type	HTG-C3510	HTG-XR	HTG-C310/HTG-XZ	HTG-4CW2			
#50						✓	✓	✓
#100						✓	✓	✓
#200						✓	✓	✓
#400						✓	✓	✓
#800						✓	✓	✓
#1500						✓	✓	✓
#3000						✓	✓	✓

Honing

Polishing

recommended for hard concrete

recommended for soft concrete and terrazo

recommended for general middle concrete

The mounting pad with the pre-installed patent designed resin discs is suitable for direct mounting on a trowel blade or other form of mounting plate in the market. Different polishing effects from cream to fine aggregate can be obtained by selecting the grit number of 1#-6#.



Sheerline Power trowel polishing system
suitable on Dry Shake hardener and refine procession

1#		
2#		
3#		
4#		
5#		
6#		

Burishing machine and pad

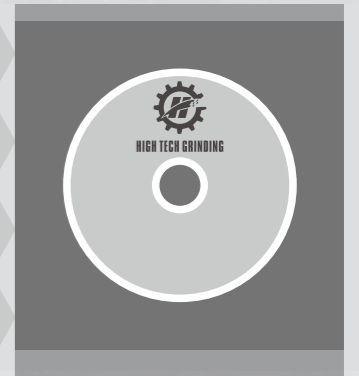

HTG

Propane machine



The HTG propane machine is available in BRIGGS & STRATTON, KOHLER and ONYX engines. Some other brands need to be sourced locally for after sales support.



HTG-800-4P

* HTG-800-3P is available with 3 planetary discs



HTG-680-4P

* HTG-680-3P is available with 3 planetary discs



HTG-700P



Conglory is a sub-brand of XINGYI - The leading manufacturer of concrete grinding and polishing equipment.

In 2020, XINGYI decided to invest in surface preparation equipment based on its R&D experience, advanced manufacturing technology and extensive marketing resources in nearly 20 years. And thanks to our German experts and engineers, Conglory is very happy to show you our surface preparation equipment with high efficiency, high quality and perfect design and production. All equipment of Conglory is completely finished by XINGYI, a company passed ISO9001, CE, SGS certificate, and QC controlling in all procession by one factory.

So far, our machines include medium size scarifier/shaver, portable shot blasting machine, single head grinder.

All our products focus on providing complete machinery solution on concrete protection coating, polished concrete, self levelling cement and mortar, decorative concrete and terrazzo, waterproof and will cover, road and bridge, airport, new construction, renovation and maintenance.

SURFACE PREPARATION EQUIPMENT

Single head or Twin heads heavy-duty Grinders

Scarifier and Shaver

Shot Blasting Machine

Sheencreting System

CONGLORY Single head / Twin heads heavy-duty GRINDERS TO LEVEL UNEVEN FLOORS AND REMOVE THICK COATINGS

CONGLORY specialises in the production of single and twin head floor grinding machines. More user-friendly design with adjustable speed, make CONGLORY machine an ideal equipment not only for your waterproof coating, produced in surface preparation and decorative flooring, but also in decontamination and demolition markets. Ideal for levelling any uneven floors without having to remove too much material, and perfect for the removal of old paints / coatings / glues.



CG-580

CG-250

Working Width	570mm	250mm
Motor Power	5.5kw	5.5kw
Voltage	380-480V 3P 200-240V 1P/3P	380-480V 3P 200-240V 1P/3P
Frequency	50/60hz	50/60hz
Rotating Speed	350-1500rpm	350-2000rpm
Grinding disc	310mm*2	250mm*1
Weight	201kg	183kg
Appearance size	1487*572*944mm	1716*435*1225mm

CG-250

- Super power for greater efficiency
- Handle can be folded forward
- Easy corner grinding
- Super power grinding at uneven areas
- Fit for various of tools

CG-580

- Super power for greater efficiency
- Handle can be folded forward
- Double the efficiency by increasing the grinding width
- Super power grinding at uneven areas
- Fit for various of tools

optional abrasives

- 10inch diamond cup wheel
- bush hammer
- resin abrasive
- metal abrasive

CONGLORY SCARIFIER AND SHAVER TO LEVEL LARGE SURFACES OR REMOVE THICK COATINGS

In scarifying, cutters are loosely fitted on lateral shafts which are placed inside a drum housing and the drum is placed inside the machine. Once the machine is switched on, the rotating drum generates a centrifugal force which throws the cutter onto the surface, and creating a mechanical cutting action. Scarifier can be used to remove difficult coatings such as glues, rubber, and other coatings from floors and hard and thick layers of concrete and asphalt on highways and runways.

With a shaving function, a drum equipped with diamond blades is placed inside a drum housing. Once the machine is switched on, the drum rotates at a very high speed to grind off the surface. In addition, this technology is ideal for applications where limited vibrations are required. Shaving is perfect to remove everything you can't remove with other technologies, without creating much vibration.



CS-320E

CS-250E

Motor Power	15 kW / 20 hp	7.5 kW / 10 hp
Voltage	380V/220V 3P	380V/220V 3P
Weight	309.5kg+87kg	170kg
Working depth	6-10mm	3-5mm
Working Width	320mm	250mm
Operate	0-23m/min self-propelled	Walk behind / with disc break

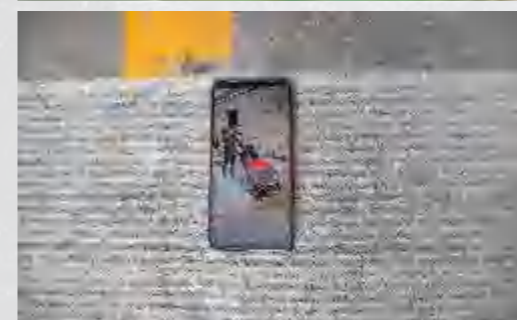

CS320E Accessories included



CS250E Accessories included





CB1-10E/CD-556B
250mm



CB2-20E/CD-756B
550mm



CB1-10E4/CD-553B
250mm

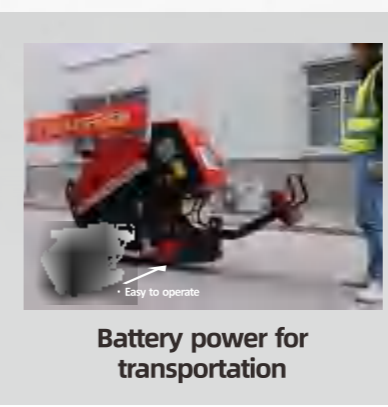
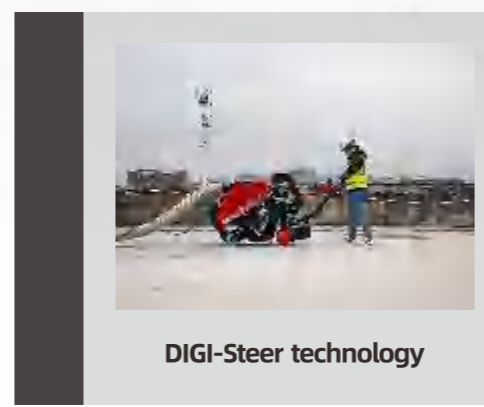
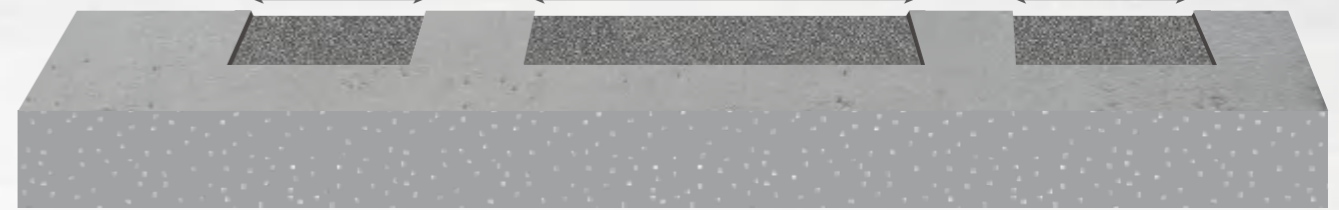

CONGLORY



CONGLORY SHOT BLASTING TO CLEAN AND RETEXTURE CONCRETE OR ASPHALT, STEEL

CONGLORY closed-circuit media blasters use centrifugal force to throw a large amount of steel abrasive onto the surface. After the steel abrasive hits the surface, the blaster recycles the media. Dust and contaminants are removed by an air wash separator and sent to a dedicated dust collector. This makes the process virtually dust-free in operation. Shot blasting is the most environment-friendly method of abrasive blasting as there is no use of chemical products and no waste of valuable water. To clean and prepare surfaces such as steel, concrete and asphalt to be paved or coated. To improve skid resistance on surfaces such as pavements, cycle paths, roads and runways. To create visual and aesthetic effects on surfaces such as roadways and runways.

**SHOT BLASTING
DUST COLLECTOR**



CB1-10E



CD-556B



CB2-20E



CD-756B



CB1-10E4



CD-553B

Motor Power	11 kW	5.5 kW	11 kW*2	5.5 kW	7.5 kW	4.5 kW
Voltage	380V 3P 220V 3P	380V 3P	380V 3P 220V 3P	380V 3P	380V 3P 220V 3P	380V 3P 220V 3P
Weight	380kg	647kg	570kg	647kg	265kg	249kg
Working Width	250mm		550mm		250mm	
Production rate	> 150 m ² / h		> 300 m ² / h		> 50 m ² / h	
Operate	DIGI-steer systems with integrated drive 0-23m/min self-driver		DIGI-steer systems with integrated drive 0-20m/min self-driver		0-20m/min self-driver	
Vacuum		250mm		250mm		40 kPa
Maximum flow		1100m ³ /h		1600m ³ /h		1100m ³ /h
Filter cleaning		Automatic jet-pulse		Automatic jet-pulse		Automatic jet-pulse
Hose		150 mm		150 mm		80 mm
Collection		continuous drop-down bag		continuous drop-down bag		continuous drop-down bag
Appearance size	1985*490*1200mm	1635*970*1784mm	2106*723*1200mm	1635*970*1784mm	1550*525*1120mm	1798*629*1490mm



www.xingyimachine.com

These Concrete Surface Profiles were developed by the International Concrete Repair Institute (ICRI), are divided into ten classifications (CSP 1-10) of surface textures based on the average distance from the peaks of the surface to the valleys. They are accepted industry standards to help guide the installer achieve the proper texture for successful bonding of the overlay or coating. The lower number profiles are smoother (CSP 1 is nearly flat), and the higher numbers have more "tooth" and get progressively rougher.

Recommended surface preparation technique for different CSP	CSP-1	CSP-2	CSP-3	CSP-4	CSP-5	CSP-6	CSP-7	CSP-8	CSP-9	CSP-10

Sealers:
0-3 mils / 0-0.075 mm

CSP1—CSP2



Thin Films:
4-10 mils / 0.1-0.25 mm

CSP2—CSP3



High-Build Coatings:
10-40 mils / 0.25-1 mm

CSP3—CSP5



Self-Leveling Toppings:
50 mils-1/8 inch / 1.25-3.175 mm

CSP4—CSP6



Polymer Overlays:
1/8 inch-1/4 inch / 3.175-6.35mm

CSP5—CSP9



Concrete Overlays & Repair Materials:
1/4 inch+ / 6.35 mm+

CSP5—CSP10





Sheencreting



CRP-1620



CRP-1950

Description	Special design with 2*4 round adapters for Conglory Sheencreting system. Does not have a normal finishing function, for trowel polishing ONLY.	With normal finishing function and heavy torque design. Could equip with 2*4 blade adapters for Conglory Sheencreting system.
Working size	1620mm	1940mm
Pan rotate speed	155rpm	160rpm
Throttle	Hand Throttle	Foot Throttle
Net weight	363kg	280kg
Engine	Standard equipped with B&S vanguard 23hp or customized and propane engine.	Honda GX 690
Sheencreting system	2*4 designed round adapter 24 pieces	2*4 adapters design 24 pieces
Power	23 hp	18.5kW

Sheencreting System

Conglory's patented trowel polishing system- Sheencreting, can turn your power trowel to a polishing machine in 10 minutes.

The mounting pad with the pre-installed patent designed resin discs is suitable for direct mounting on a trowel blade or other form of mounting plate in the market. Different polishing effects from cream to fine aggregate can be obtained by selecting the grit number of 1#-6#.

Installation mode I

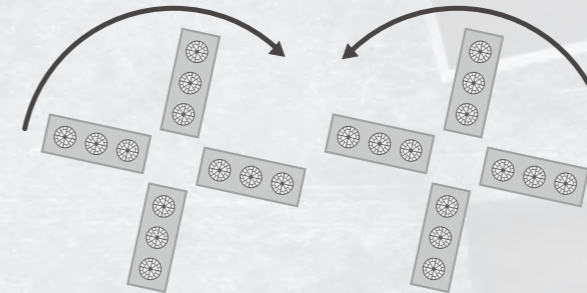

Installation mode II

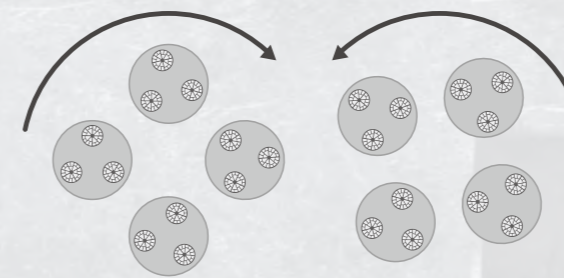

- 1#** 50grit, wet for middle exposed
- 2#** 100grit, wet for fine exposed
- 3#** 200grit, wet for cream
- 4#** 400grit, dry for middle gross polishing
- 5#** 800grit, dry for high gross polishing
- 6#** 1500grit, dry for high gross polishing



It helps you save time for taking care of the equipment cables or generating airborne dust, it helps you easily polish up to 10,000 square feet per day with a Conglory ride-on power trowel CRP-1950.



Contractors can use current ride-on power trowels for polishing projects with our patented Sheencreting System Kit, not only increasing revenue, but more effectively ensuring project quality. Entering the polishing market with little investment and simple steps can create unique effects that greatly increase customer satisfaction. There is no need to invest in additional equipment and no need to double up on secondary construction. Construction time is greatly reduced. Even the old abrasive wear resistant floors are easy to renovate.



1# 2# 3#
Patented Sheencreting System 1#2#3# is suitable for wet polishing on original concrete floor, dry shake or renovating the old ground.

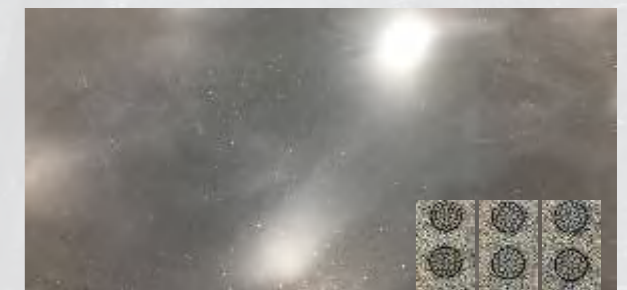

4# 5# 6#
Patented Sheencreting System 4#5#6# is suitable for 100% dry polishing of original concrete floor, renovating old or new floors.

